

Fine-grained language composition



Edd Barrett



Carl
Friedrich
Bolz



Lukas
Diekmann



Laurence
Tratt



Naveneetha
Krishnan
Vasudevan

KING'S
College
LONDON

Software Development Team
2015-07-07

Language composition challenges

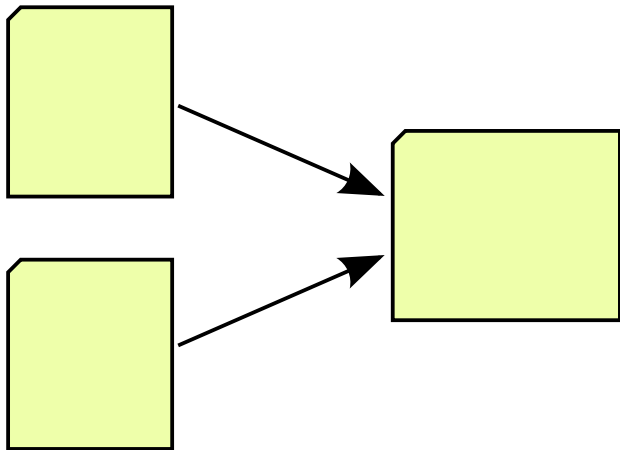

Language composition challenges

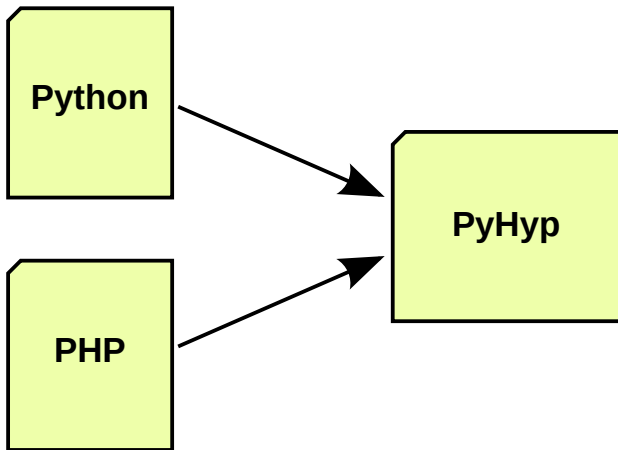

Language composition challenges

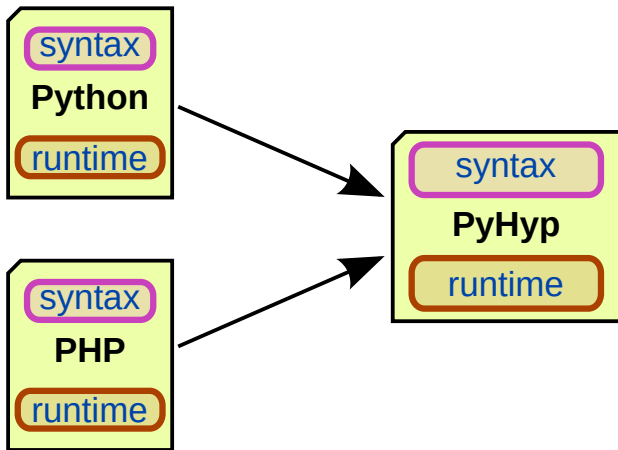

Language composition challenges

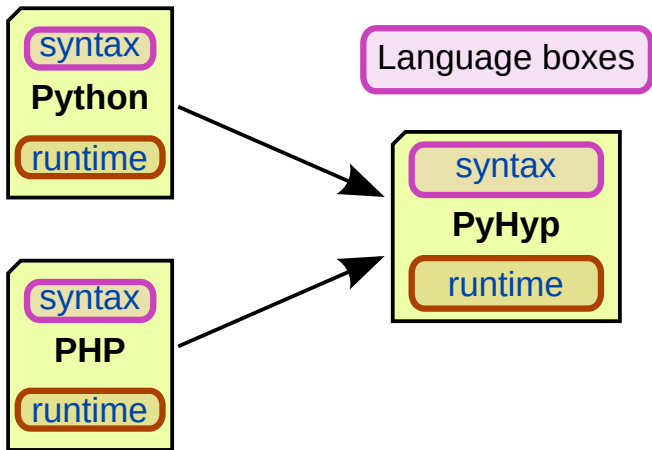

Language composition challenges

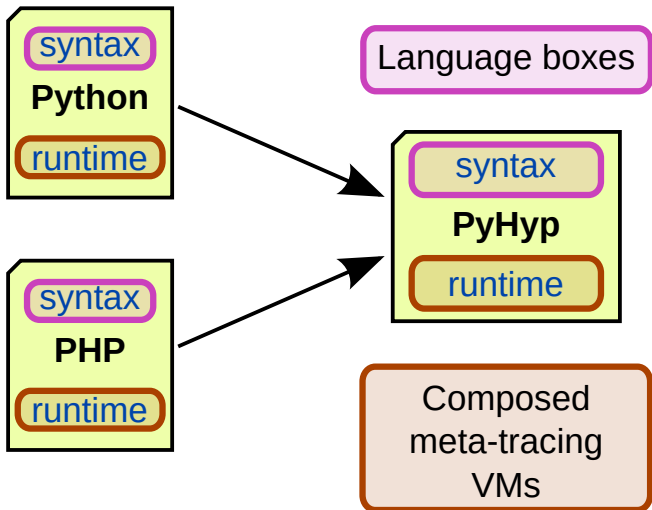

Meta-tracing interpreter composition

Meta-tracing interpreter composition

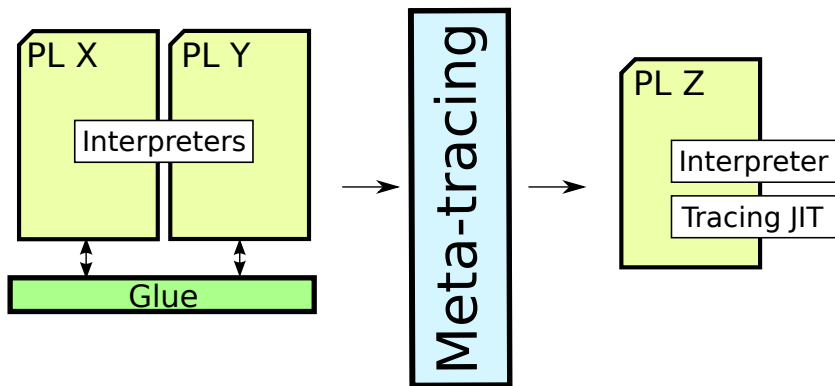

Meta-tracing interpreter composition

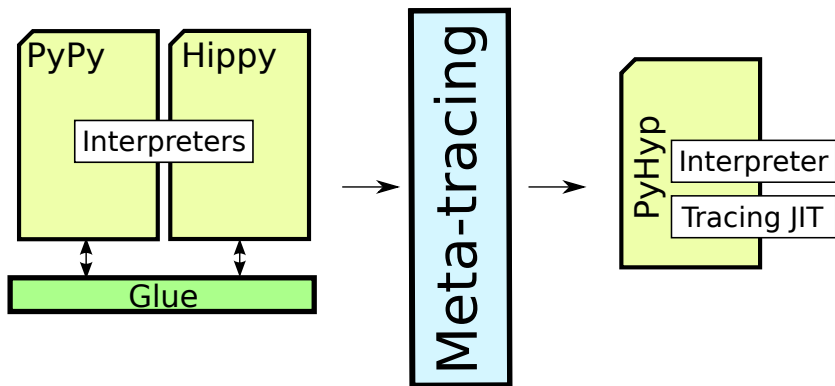

Basic functionality

Friction

A good composition needs to reduce *friction*.

Friction

A good composition needs to reduce *friction*. Some examples:

- Lexical scoping (or lack thereof) in PHP and Python (semantic friction)

Friction

A good composition needs to reduce *friction*. Some examples:

- Lexical scoping (or lack thereof) in PHP and Python (semantic friction)
- PHP datatypes are immutable except for references and objects; Python's are largely mutable (semantic and performance friction)

Friction

A good composition needs to reduce *friction*. Some examples:

- Lexical scoping (or lack thereof) in PHP and Python (semantic friction)
- PHP datatypes are immutable except for references and objects; Python's are largely mutable (semantic and performance friction)
- PHP has only dictionaries; Python has lists and dictionaries (semantic friction)

Datatype conversion

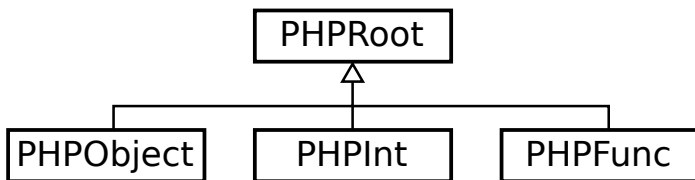

Datatype conversion

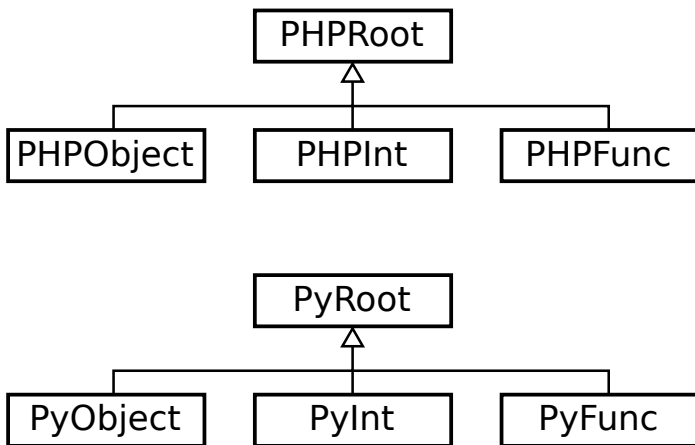

Datatype conversion: primitive types

PHP

Python

Datatype conversion: primitive types

PHP

2 : PHPInt

Python

Datatype conversion: primitive types

PHP

2 : PHPInt

Python

2 : PyInt

Datatype conversion: user types

PHP

Python



Datatype conversion: user types

PHP

`o : PHPObject`

Python

Datatype conversion: user types

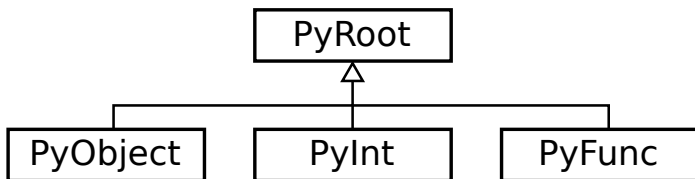

Datatype conversion: user types

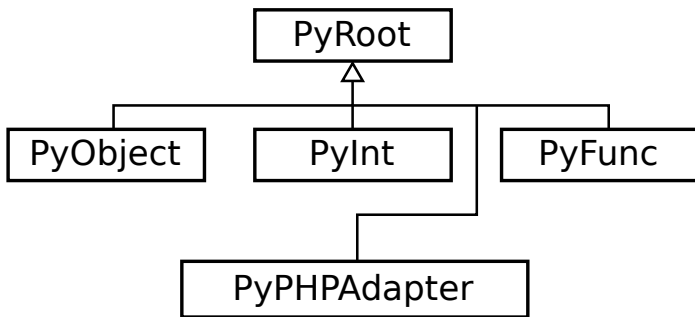

Datatype conversion: user types

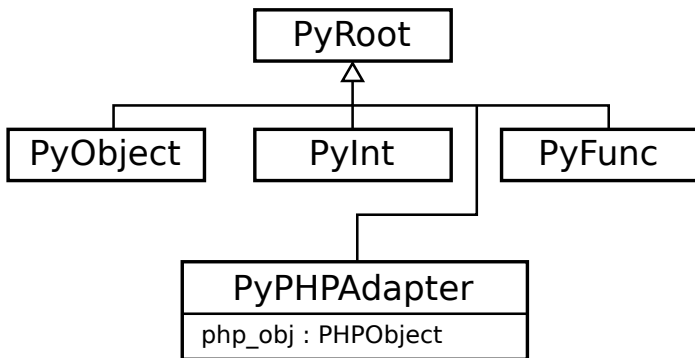

Datatype conversion: user types

PHP

`o : PHPObject`

Python

Datatype conversion: user types

PHP

`o : PHPObject`

Python

`:PyPHPAdapter`

Datatype conversion: user types

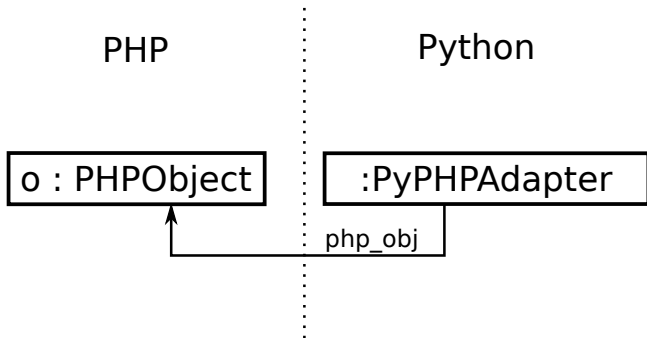

Datatype conversion: user types

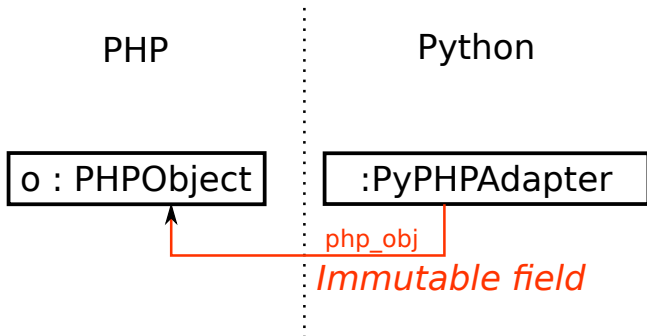

Warning: draft (warmed up) numbers ahead!

Composed Richards vs. other VMs

Type	VM	
Mono	CPython 2.7.7	9.475 ± 0.0127
	HHVM 3.4.0	4.264 ± 0.0386
	HippyVM	0.250 ± 0.0008
	PyHyp	0.257 ± 0.0011
	PyPy 2.4.0	0.178 ± 0.0006
	Zend 5.5.13	9.070 ± 0.0361

Composed Richards vs. other VMs

Type	VM	
Mono	CPython 2.7.7	9.475 ± 0.0127
	HHVM 3.4.0	4.264 ± 0.0386
	HippyVM	0.250 ± 0.0008
	PyHyp	0.257 ± 0.0011
	PyPy 2.4.0	0.178 ± 0.0006
	Zend 5.5.13	9.070 ± 0.0361
Composed	PyHyp	0.335 ± 0.0012

Namespaces

Unipycation

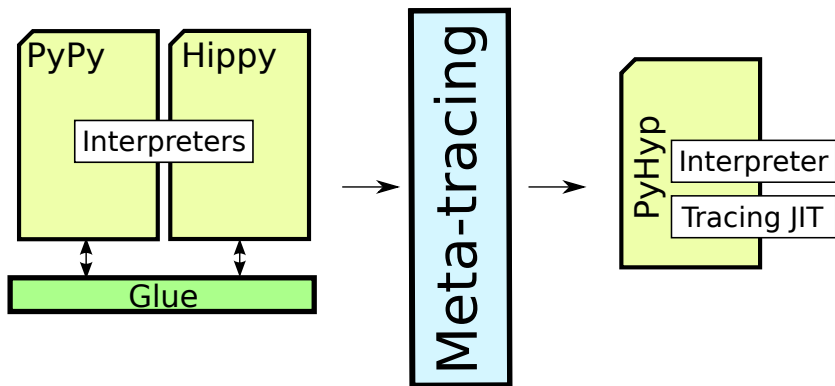

Unipycation

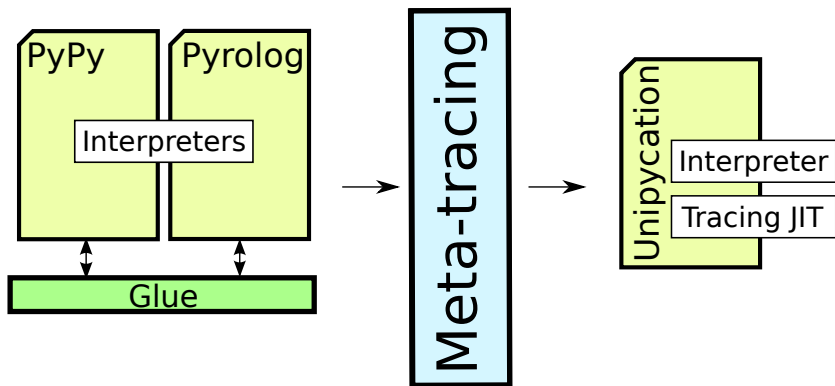

Absolute timing comparison

VM	Benchmark	<i>Python</i>		<i>Prolog</i>		<i>Python</i> → <i>Prolog</i>	
CPython-SWI	SmallFunc	0.125s	±0.007	0.257s	±0.002	28.893s	±0.227
	L1A0R	2.924s	±0.284	7.352s	±0.048	9.310s	±0.084
	L1A1R	4.184s	±0.038	18.890s	±0.111	20.865s	±0.067
	NdL1A1R	7.531s	±0.080	18.643s	±0.197	667.682s	±6.895
	TCons	264.415s	±2.250	48.819s	±0.252	2185.150s	±18.225
	Lists	9.374s	±0.059	25.148s	±0.221	2207.304s	±16.073
Unipycation	SmallFunc	0.001s	±0.000	0.006s	±0.001	0.001s	±0.000
	L1A0R	0.085s	±0.000	0.086s	±0.000	0.087s	±0.000
	L1A1R	0.112s	±0.000	0.114s	±0.000	0.115s	±0.000
	NdL1A1R	0.500s	±0.003	0.548s	±0.085	2.674s	±0.012
	TCons	6.053s	±0.288	2.444s	±0.003	36.069s	±0.225
	Lists	0.845s	±0.002	1.416s	±0.003	5.056s	±0.035
Jython-tuProlog	SmallFunc	0.088s	±0.003	3.050s	±0.053	52.294s	±0.475
	L1A0R	1.078s	±0.009	206.590s	±3.846	199.963s	±2.476
	L1A1R	2.145s	±0.232	293.311s	±5.691	294.781s	±6.193
	NdL1A1R	7.939s	±0.457	1857.687s	±5.169	1990.985s	±15.071
	TCons	543.347s	±3.289	8014.477s	±17.710	8202.362s	±24.904
	Lists	5.661s	±0.046	6981.873s	±18.795	5577.322s	±15.754

Relative timing comparison

VM	Benchmark	$\frac{\text{Python} \rightarrow \text{Prolog}}{\text{Python}}$		$\frac{\text{Python} \rightarrow \text{Prolog}}{\text{Prolog}}$		$\frac{\text{Python} \rightarrow \text{Prolog}}{\text{Unipycation}}$	
CPython-SWI	SmallFunc	231.770×	±13.136	112.567×	±1.242	27821.079×	±2331.665
	L1A0R	3.184×	±0.300	1.266×	±0.014	107.591×	±0.995
	L1A1R	4.987×	±0.049	1.105×	±0.007	181.899×	±0.590
	NdL1A1R	88.654×	±1.368	35.814×	±0.554	249.737×	±2.922
	TCons	8.264×	±0.101	44.760×	±0.453	60.583×	±0.637
	Lists	235.459×	±2.314	87.772×	±1.017	436.609×	±4.415
Unipycation	SmallFunc	1.295×	±0.105	0.182×	±0.054	1.000×	
	L1A0R	1.020×	±0.002	1.012×	±0.002	1.000×	
	L1A1R	1.025×	±0.002	1.002×	±0.003	1.000×	
	NdL1A1R	5.349×	±0.045	4.879×	±0.924	1.000×	
	TCons	5.959×	±0.282	14.756×	±0.092	1.000×	
	Lists	5.982×	±0.045	3.569×	±0.026	1.000×	
Jython-tuProlog	SmallFunc	592.904×	±19.517	17.143×	±0.338	50354.204×	±4341.413
	L1A0R	185.460×	±2.818	0.968×	±0.021	2310.844×	±28.093
	L1A1R	137.427×	±14.537	1.005×	±0.028	2569.873×	±52.847
	NdL1A1R	250.776×	±14.666	1.072×	±0.009	744.699×	±6.726
	TCons	15.096×	±0.106	1.023×	±0.004	227.409×	±1.592
	Lists	985.149×	±8.674	0.799×	±0.003	1103.206×	±8.338

Thanks to our funders

- EPSRC: *COOLER* and *Lecture*.
- Oracle: various.

Thanks for listening

```
1: <html>
2: <head>
3: <import sqlite3
4: c = sqlite3.connect("/home/ltratt/scratch/demo/test.db")
5: </head>
6: <body>
7: <h1>hello</h1>
8: for n, in SELECT name FROM people:
9:     print n
10: </body>
11: </html>
```

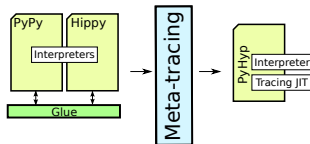
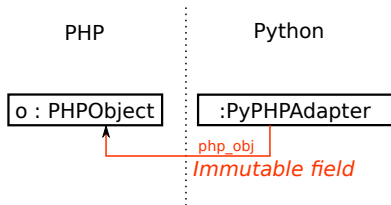
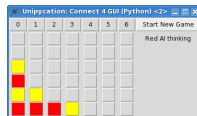

<http://soft-dev.org/>